

Product Catalogue



WolkeSieben



WWW.PIPS.CO.ZA

 pips



WolkeSieben

We work with well-known designers and design teams, because we think that there is more to product development than finding a form that will be in demand. Good design will always support the function of a product as well, and will ideally do so at all levels, from inspiring planning, to safe assembly, to easy, comfortable use. All the designs are original and patented.

**All the designs are unique,
original and patented.**



VP1
BASIN SIRENA
660×360×185mm



VP2
BASIN RELAXO
420×420×120mm

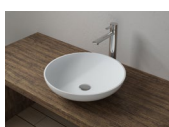

VP3
BASIN CALMO
450×450×120mm

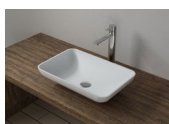

VP4
BASIN LUSSO
520×340×120mm



V40
BASIN ADDA
450×450×150mm



V42
BASIN ANIMA
580×360×150mm



V43
BASIN FONTANA
560×360×150mm



V79
BASIN BRENTO
600×450×120mm



C1
BASIN ROMA
600×400×150mm



V20
BASIN PURRO
600×360×215mm

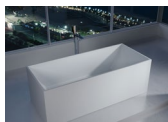

TC-S107
BATHTUB
1700×730×580mm

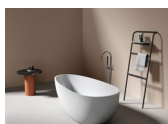

WS6007L
BATHTUB
1700×800×560mm

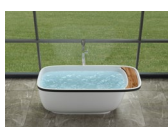

V125S-B
BATHTUB
1700×720×560mm

MATERIALS

POLYSTONE (STONE RESIN)

WolkeSieben's solid surface is a special blend of resins and advanced polymers. The material used in the production process is of the highest quality, which ensures that all our products are eco-friendly.

The exclusive polymer composition of WolkeSieben products brings superior resistance against harsh chemicals and staining, whilst offering high durability.

QUALITY AND AESTHETICS

WolkeSieben products are benchmarked with special detail to texture and aesthetic design. Our basins and bathtubs bestow superior resistance and are free of defects. Any defects identified in our products will be immediately resolved with a replacement.

HIGH QUALITY

Smaller scratches occur in the product life cycle. They can always be easily removed with polishing compound. Our products are very durable and almost immune to common dirt, bacteria, or scratches.

EASY MAINTENANCE

Regular cleaning with common non-abrasive cleaning agents will secure a long surface quality. Our material is resistant to deterioration and minor damages due to wrong handling can

even be easily repaired.

NON-POROUS

WolkeSieben's solid surface is 100% non-porous and therefore unaffected by fluctuating moisture, ingression, or leakage. Any common dirt, bacteria, or scratches should always be easily removed with water and regular cleaning agents.

MADE IN UNITED KINGDOM

In order to secure long-lasting color, WolkeSieben is importing the color pigments from the United Kingdom for a high-quality result.

GUARANTEES

WolkeSieben is proud to offer a limited 10-year international warranty on all its products.

Basin Sirena

Size: 660×360×185mm

Artificial Stone

White

VP1



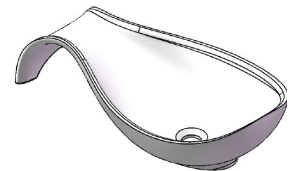
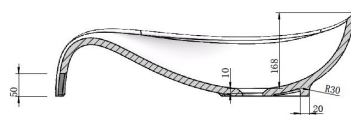
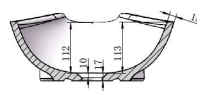
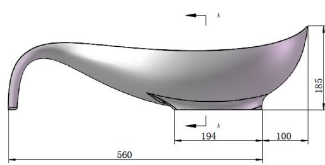
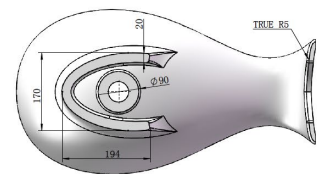
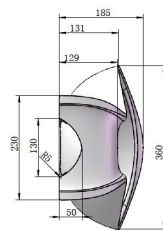
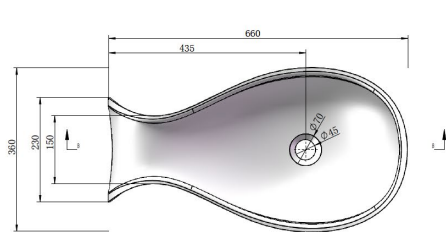

Basin Relaxo

Size: 420×420×120mm

Artificial Stone

White

VP2



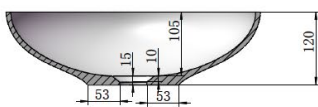
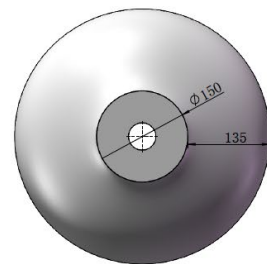
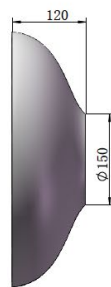
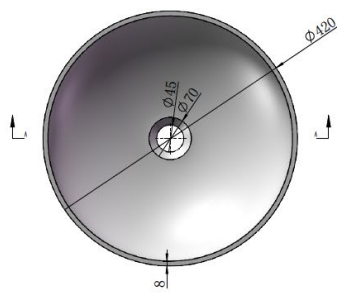

Basin Calma

Size: 450×450×120mm

Artificial Stone

White

VP3



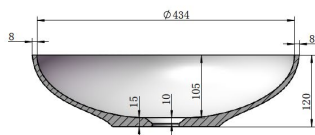
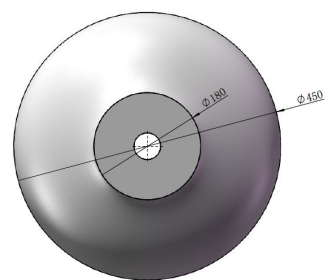
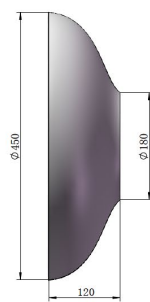
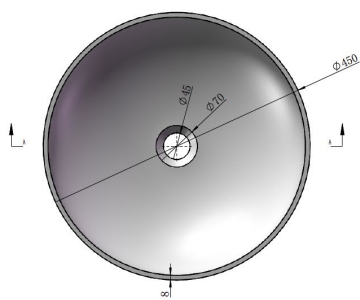

Basin Lusso

Size: 520×340×120mm

Artificial Stone

White

VP4



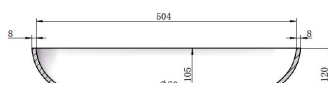
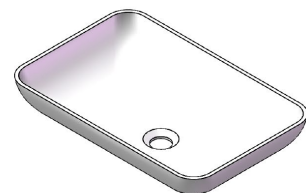
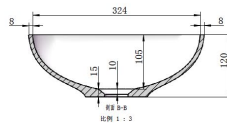
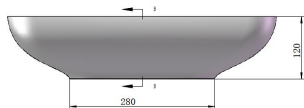
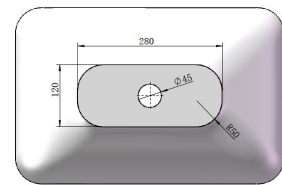
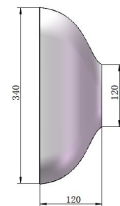
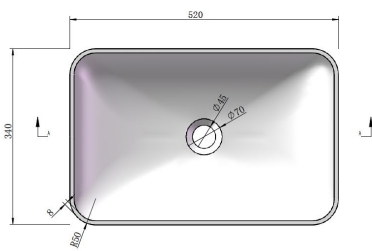

Basin Adda

Size: 450×450×150mm

Artificial Stone

White

V40

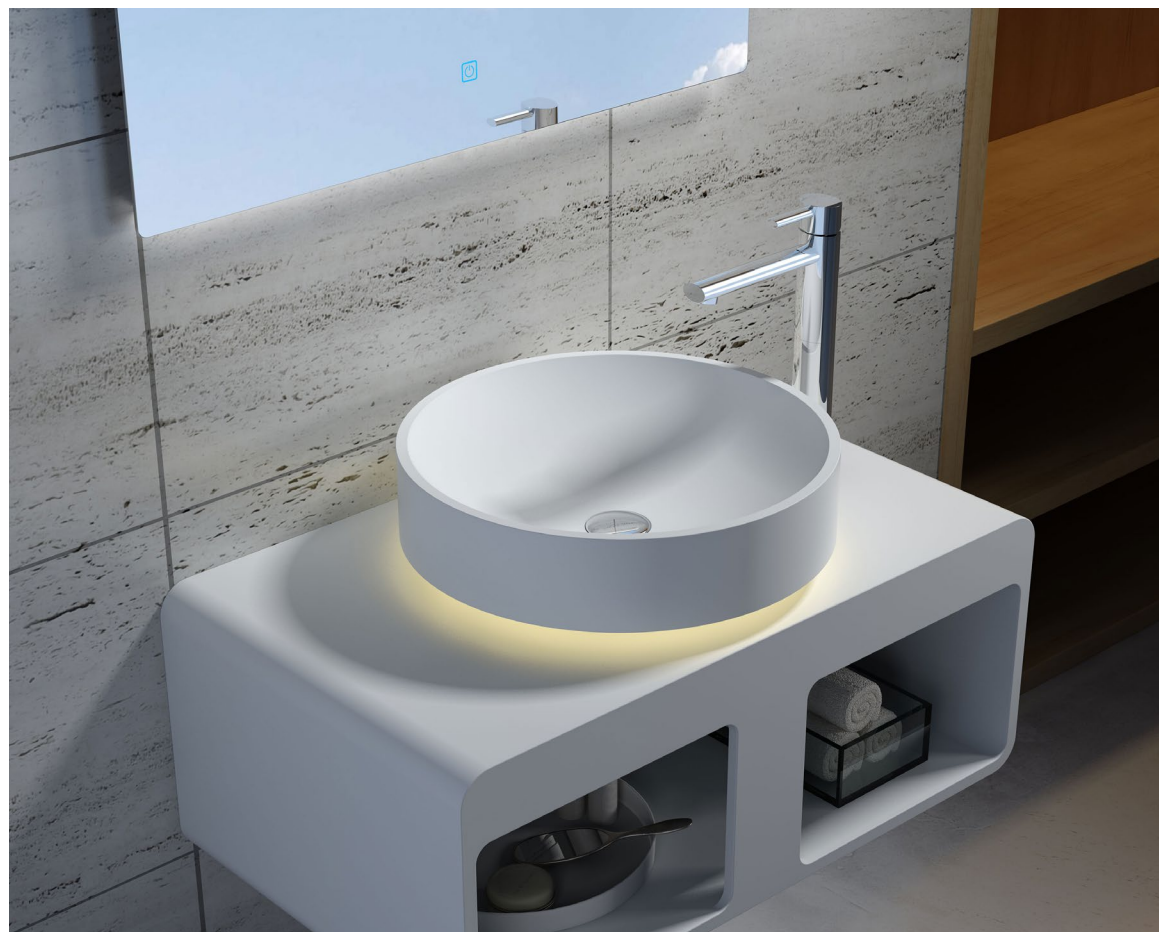

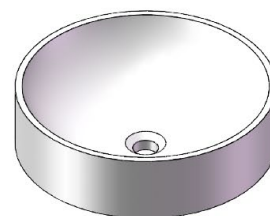
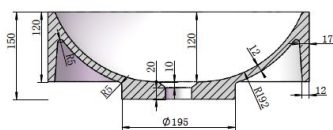
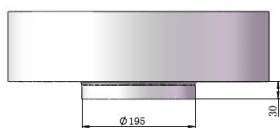
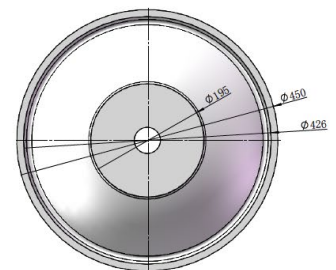
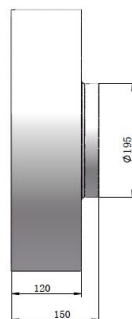
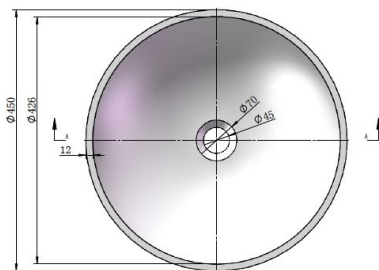

Basin Anima

Size: 580×360×150mm

Artificial Stone

White

V42



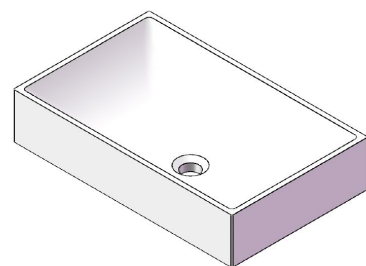
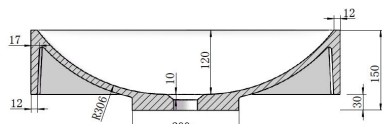
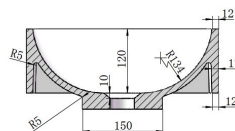
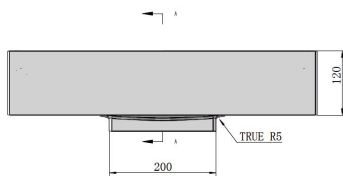
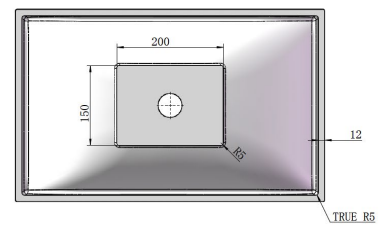
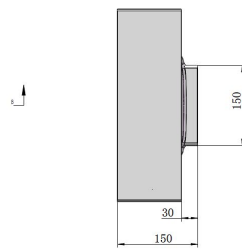
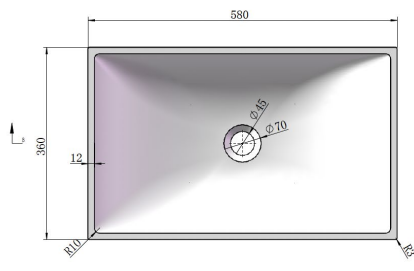

Basin Fontana

Size: 560×360×150mm

Artificial Stone

White

V43



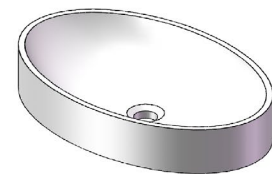
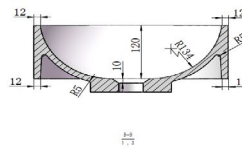
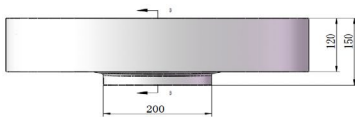
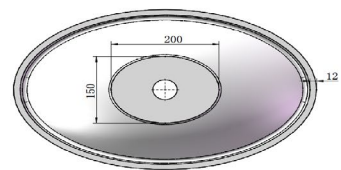
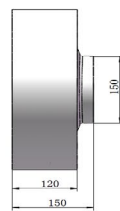
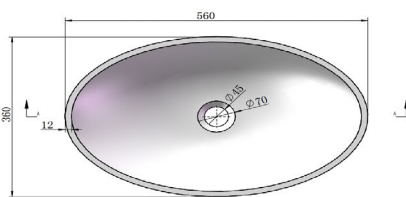

Basin Brento

Size: 600×450×120mm

Artificial Stone

White

V79



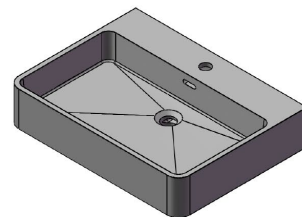
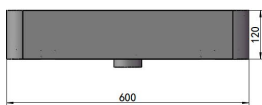
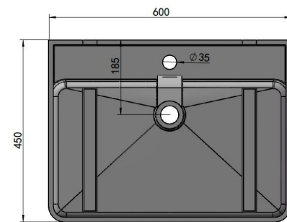
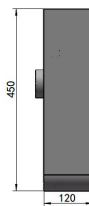
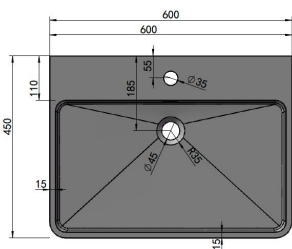

Basin Roma

Size: 600×400×150

Artificial Stone

White

C1



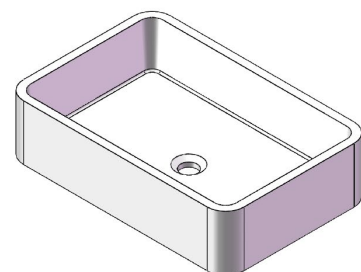
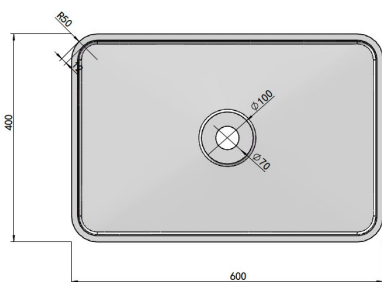
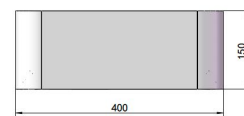
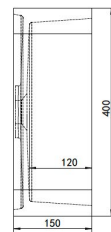
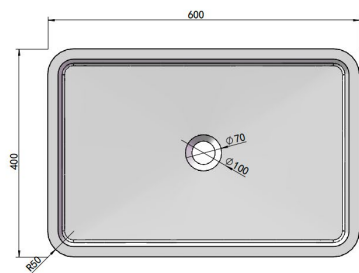

Basin Purro

Size: 600×360×215mm

Artificial Stone

White

V20



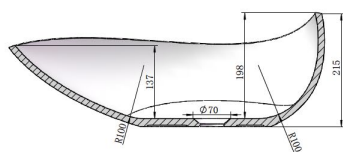
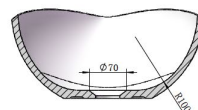
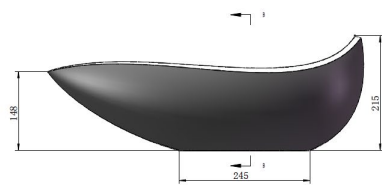
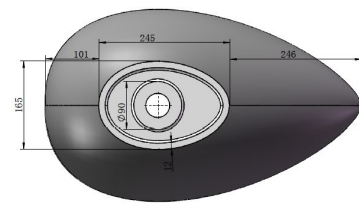
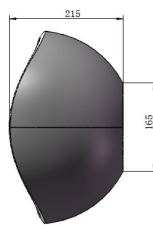
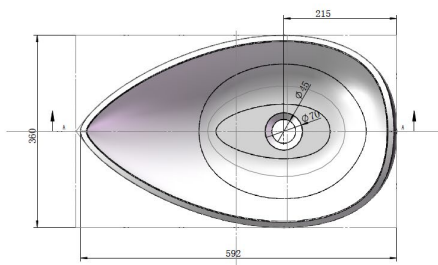

Bath Aqua Dolce

Size: 1700×730×580mm

Artificial Stone

White

TC-S107



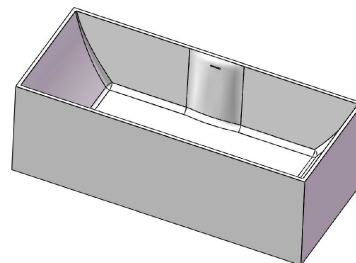
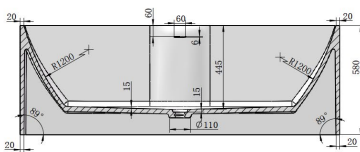
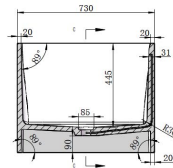
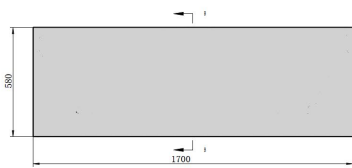
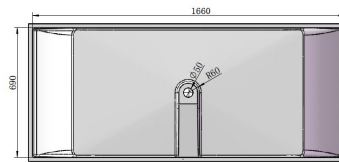
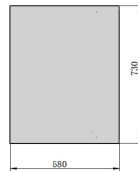
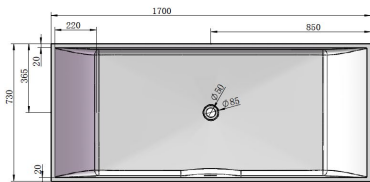

Bath Aqua Bella

Size: 1700×800×560MM

Artificial Stone

White

WS6007L



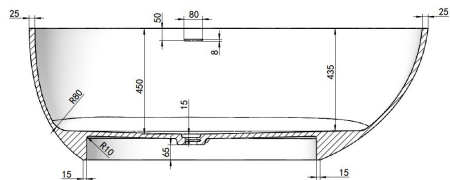
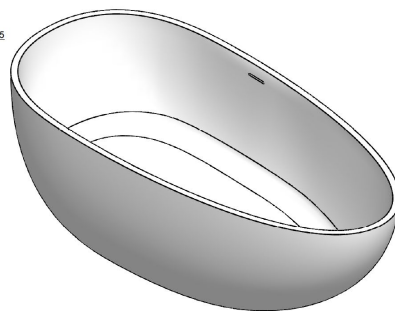
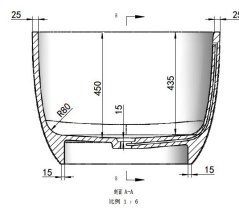
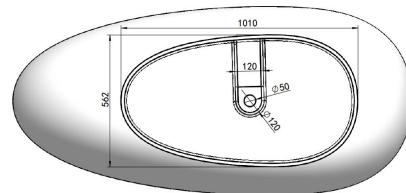
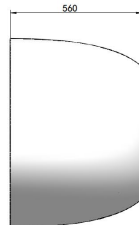
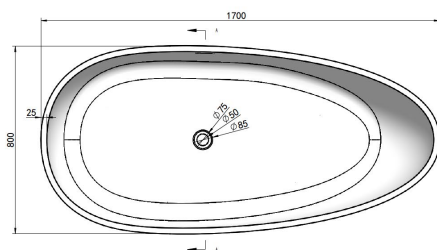

WOLKESIEBEN

Bath Aqua Dona

Size: 1650×720×580mm

Artificial Stone

White

V125S-B



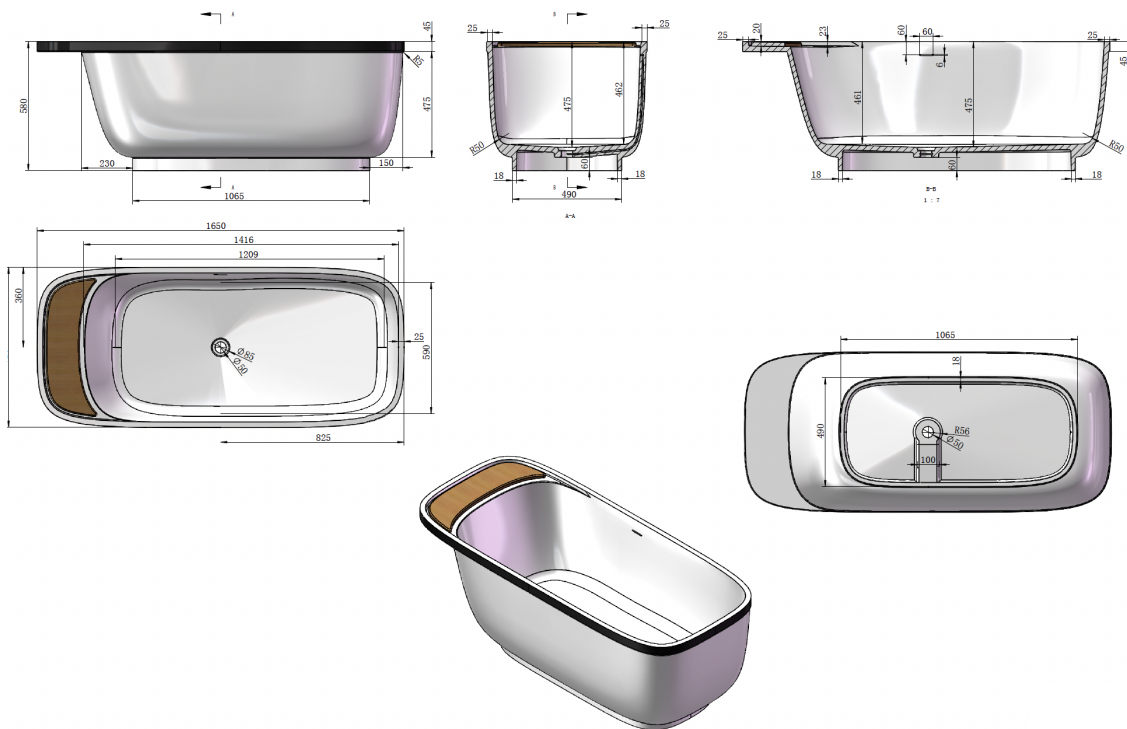



WolkeSieben

ADDRESS

8 Robberg Road
Plettenberg Bay
6600

GET IN TOUCH

(+27) 44 533 4242
sales@pips.co.za
www.pips.co.za

The logo for Pips, consisting of a stylized blue lowercase 'p' followed by the lowercase letters 'pips' in white. The 'p' is bold and has a small square cutout at its base.